

## New standard ASi-5



(figure similar)



Figure	Type	Inputs digital	Outputs digital	M12 connection (1)	Input voltage (sensor supply) (2)	Output voltage (actuator supply) (3)	ASi connection (4)	ASi address (5)	Max. output current	Art. no.
	IP67, 8 x M12 ASi-5	8	–	single	out of ASi	–	ASi profile cable	1 ASi-5 slave	–	<b>BWU3802</b>
	IP67, 8 x M12, ASi-5	8	–	single	out of AUX	–	ASi profile cable	1 ASi-5 slave	–	<b>BWU3893</b>
	IP67, 8 x M12 ASi-5	8	8 x electronic	Y	out of ASi	out of AUX	ASi profile cable	1 ASi-5 slave	1 A per output	<b>BWU3163</b>
	IP67, 8 x M12 ASi-5	8	8 x electronic	Y	out of AUX	out of AUX	ASi profile cable	1 ASi-5 slave	1 A per output	<b>BWU4207</b>
	IP67, 8 x M12 ASi-5	16	–	Y	out of ASi	–	ASi profile cable	1 ASi-5 slave	–	<b>BWU3164</b>
	IP67, 8 x M12 ASi-5	16	–	Y	out of AUX	–	ASi profile cable	1 ASi-5 slave	–	<b>BWU3890</b>

(1) **M12 wiring:** either as a single-wiring, Y-wiring or mixed-wiring.

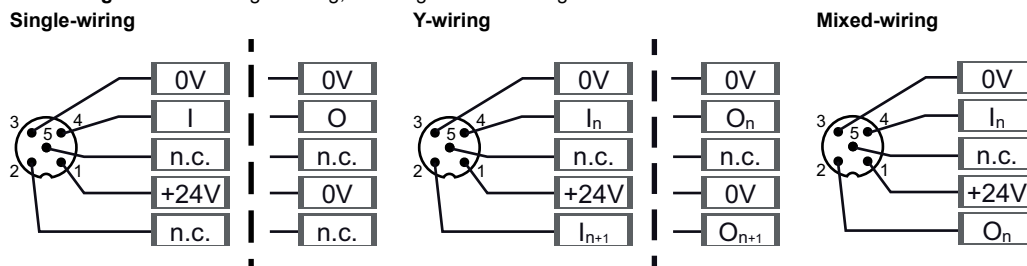

- (2) **Input voltage (sensor supply):** inputs are supplied by ASi or by AUX (auxiliary 24 V power). If supplied by ASi, inputs shall not be connected to earth or to external potential.
- (3) **Output voltage (actuator supply):** outputs are supplied by ASi or by AUX (auxiliary 24 V power). If supplied by ASi, outputs shall not be connected to earth or to external potential
- (4) **ASi connection:** the connection to ASi as well to AUX (auxiliary 24 V power) is made via yellow resp. black ASi profile cable with piercing technology or via M12 socket (in IP20 via clamps).
- (5) **ASi address:** AB slave (max. 62 AB slaves/ASi network), 2 AB slaves (max. 31 modules with 2 AB slaves), single slaves (max. 31 single slaves/ASi network) ASi-5 slave (max. 62 ASi-5 slaves/ASi network), mixed use allowed (upon request, slaves are available with specific ASi slave profiles).

Article No.	BWU3802	BWU3164	BWU3893	BWU3890	BWU3163	BWU4207
<b>General data</b>						
Device type	input			input / output		
<b>Connection</b>						
ASi/AUX connection	profile cable and piercing					
Periphery connection	M12, single wiring	M12, Y wiring	M12, single wiring	M12, Y wiring		
Length of connector cable	unlimited <sup>(1)</sup>					
<b>ASi</b>						
Address	1 ASi-5 slave					
Required Master profile	M5					
As of ASi specification	5					
Operating voltage	30 V (18 ... 31.6 V)					
Max. current consumption	120+70 mA		70 mA		120+70 mA	70 mA
Max. current consumption without sensor/ actuator supply	70 mA					
<b>AUX</b>						
Operating voltage	-		24 V (18 ... 30 V)			
Max. current consumption	-		1 A		6 A	
<b>Input</b>						
Number	8	16	8	16	8	
Power supply	out of ASi		out of AUX		out of ASi	out of AUX
Sensor supply	short-circuit and overload protected according to EN 61131-2					
Power supply of attached sensors	up to +40 °C	120 mA <sup>(2)</sup>		1 A <sup>(6)</sup>		120 mA <sup>(7)</sup>
	at +55 °C	80 mA <sup>(2)</sup>		0,9 A <sup>(5)</sup>		70 mA <sup>(6)</sup>
	at +70 °C	50 mA <sup>(2)</sup>		0,5 A <sup>(5)</sup>		50 mA <sup>(6)</sup>
Switching threshold	U < 5 V (low) U > 15 V (high)					
<b>Output</b>						
Number	-					8
Power supply	-					out of AUX
Output	-					short-circuit and overload protected according to EN 61131-2
Max. output current	up to +40 °C	-				1 A per output, Σ(Out) 6 A <sup>(8)</sup>
	at +55 °C	-				1 A per output, Σ(Out) 2 A <sup>(7)</sup>
	at +70 °C	-				
<b>Display</b>						
LED ASi (green)	on: ASi voltage on flashing: ASi voltage on, but peripheral fault <sup>(3)</sup> or address 0 off: no ASi voltage					
LED FLT/FAULT (red)	on: slave address 0 or slave offline flashing: peripheral fault <sup>(3)</sup> off: slave online					
LED AUX (green)	-		on: 24 V <sub>DC</sub> AUX off: no 24 V <sub>DC</sub> AUX			
LEDs I1 ... In (yellow)	state of inputs I1 ... I8	state of inputs I1 ... I16	state of inputs I1 ... I8	state of inputs I1 ... I16	state of inputs I1 ... I8	
LEDs O1 ... On (yellow)	-					yellow: state of outputs O1 ... O8

Article No.	BWU3802	BWU3164	BWU3893	BWU3890	BWU3163	BWU4207
<b>Environment</b>						
Applied standards	EN 61000-6-2 EN 61000-6-3 EN 61131-2 EN 60529					
Passive safety (up to PLe/SIL 3)	yes <sup>(4)</sup>					
Operating altitude	max. 2000 m					
Ambient temperature	-30 °C ... +55 °C (up to max. +70 °C) <sup>(2)</sup> <sup>(5)</sup> <sup>(6)</sup> <sup>(7)</sup>					
Storage temperature	-25 °C ... +85 °C					
Housing	plastic, for screw mounting					
Pollution degree	2					
Protection category	IP67					
Tolerable loading referring to humidity	according to EN 61131-2					
Max. tolerable shock load	30g, 11 ms, acc. EN 61131-2					
Max. tolerable vibration stress	5 ... 8 Hz 50 mm <sub>pp</sub> /8 ... 500 Hz 6g, acc. EN 61131-2					
Insulation voltage	≥ 500 V					
Weight	200 g					
Dimensions (W / H / D) in mm	60 / 151 / 31					

(1) Loop resistance ≤ 150 Ω

(2) **BWU3164, BWU3802**  
**Derating power supply of attached sensors**

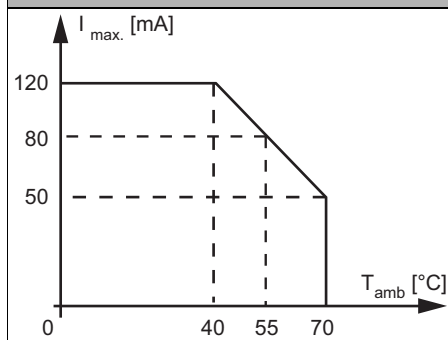

(3) See table "Peripheral fault indication"

(4) Exclusion of errors for the connection of the two ASi and AUX potentials can be assumed in the module. Passive safety for the application can only be achieved if this is ensured for all components used.

(5) Maximum ambient operating temperature +55 °C according UL certificate for the use in the USA and Canada

(6) **BWU3890, BWU3893**  
**Derating power supply of attached sensors**

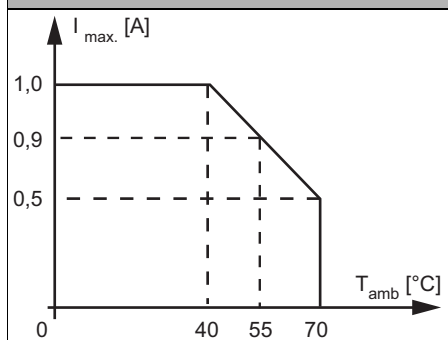

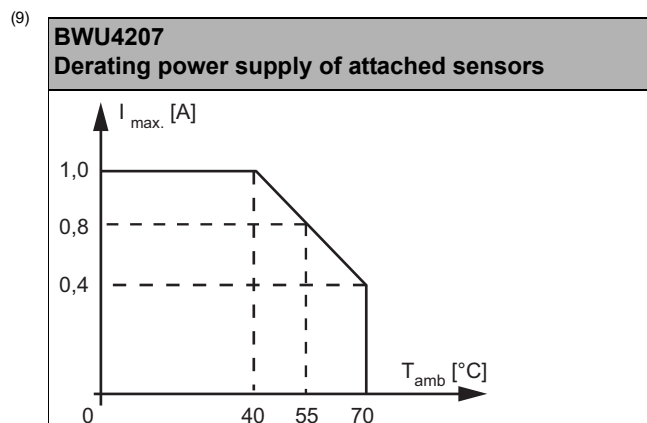
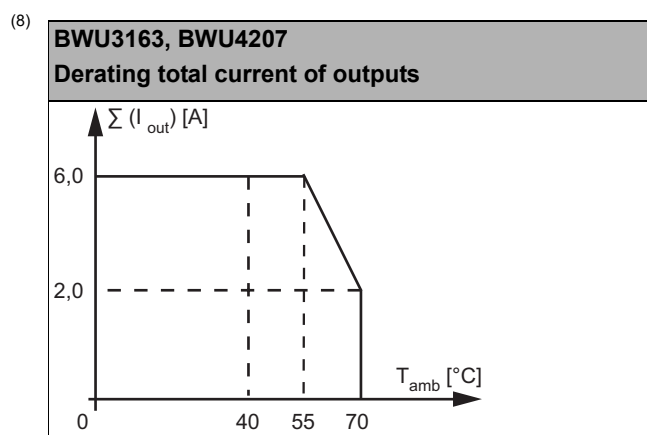
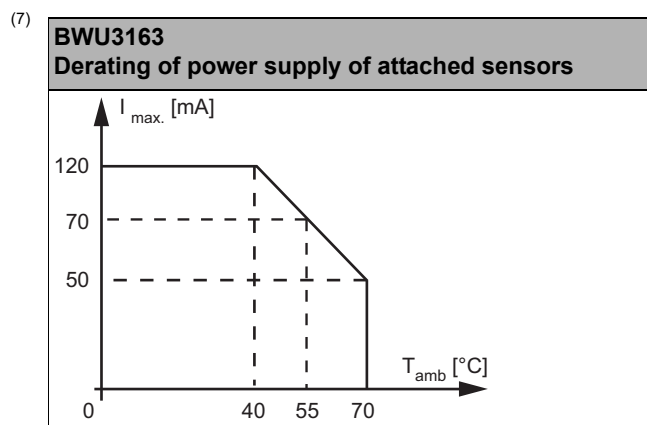

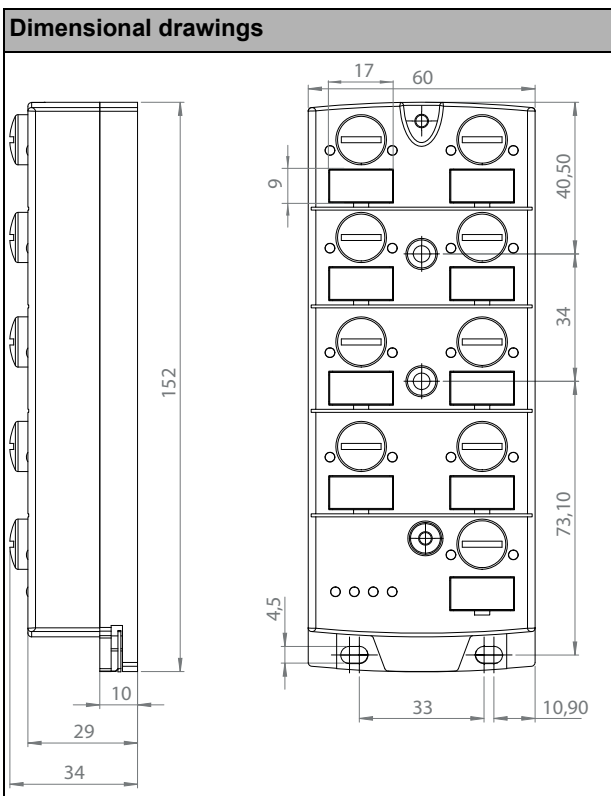

Article no.	Peripheral fault indication		
	Overload sensor supply	Output short circuited	AUX voltage missing
BWU3163	•	•	•
BWU3164	•	-	-
BWU3802	•	-	-
BWU3890	•	-	•
BWU3893	•	-	•
BWU4207	•	•	•

UL-specifications (UL508)	
BWU3163, BWU3164, BWU3802, BWU3890, BWU3893, BWU4207	
External protection	An isolated source with a secondary open circuit voltage of $\leq 30 V_{DC}$ with a 3 A maximum over current protection. Over current protection is not required when a Class 2 source is employed.
In general	UL mark does not provide UL certification for any functional safety rating or aspects of the above devices.

**Programming: ASi bit assignment**

Article no.	Byte	Bit							
		D7	D6	D5	D4	D3	D2	D1	D0
		input							
BWU3163, BWU3164, BWU3802, BWU3890, BWU3893, BWU4207	0	I8	I7	I6	I5	I4	I3	I2	I1
BWU3164, BWU3890	1	I16	I15	I14	I13	I12	I11	I10	I9

Article no.	Byte	Bit							
		D7	D6	D5	D4	D3	D2	D1	D0
		output							
BWU3163, BWU4207	0	O8	O7	O6	O5	O4	O3	O2	O1

## Pin assignment

Signal name	Explanation
Ix	digital input x
Ox	digital output x
24V <sub>ext out</sub>	power supply, out of external voltage, positive pole (AUX, actuator supply)
0V <sub>ext out</sub>	power supply, out of external voltage, negative pole (AUX, actuator supply)
24V <sub>out of ASi</sub>	power supply, out of ASi, positive pole (sensor supply)
0V <sub>out of ASi</sub>	power supply, out of ASi, negative pole (sensor supply)
ASi +, ASi -	connection to ASi bus
n.c. (not connected)	not connected

Connections							
Article no.	M12 connection	Marking	Pin1	Pin2	Pin3	Pin4	Pin5
BWU3164	X1	I1/I2	24 V <sub>out of ASi</sub>	I2	0 V <sub>out of ASi</sub>	I1	n.c.
	X2	I3/I4	24 V <sub>out of ASi</sub>	I4	0 V <sub>out of ASi</sub>	I3	n.c.
	X3	I5/I6	24 V <sub>out of ASi</sub>	I6	0 V <sub>out of ASi</sub>	I5	n.c.
	X4	I7/I8	24 V <sub>out of ASi</sub>	I8	0 V <sub>out of ASi</sub>	I7	n.c.
	X5	I9/I10	24 V <sub>out of ASi</sub>	I10	0 V <sub>out of ASi</sub>	I9	n.c.
	X6	I11/I12	24 V <sub>out of ASi</sub>	I12	0 V <sub>out of ASi</sub>	I11	n.c.
	X7	I13/I14	24 V <sub>out of ASi</sub>	I14	0 V <sub>out of ASi</sub>	I13	n.c.
	X8	I15/I16	24 V <sub>out of ASi</sub>	I16	0 V <sub>out of ASi</sub>	I15	n.c.
	ADDR (dummy plug)	connection for ASi addressing device					
BWU3890	X1	I1/I2	24 V <sub>ext out</sub>	I2	0 V <sub>ext out</sub>	I1	n.c.
	X2	I3/I4	24 V <sub>ext out</sub>	I4	0 V <sub>ext out</sub>	I3	n.c.
	X3	I5/I6	24 V <sub>ext out</sub>	I6	0 V <sub>ext out</sub>	I5	n.c.
	X4	I7/I8	24 V <sub>ext out</sub>	I8	0 V <sub>ext out</sub>	I7	n.c.
	X5	I9/I10	24 V <sub>ext out</sub>	I10	0 V <sub>ext out</sub>	I9	n.c.
	X6	I11/I12	24 V <sub>ext out</sub>	I12	0 V <sub>ext out</sub>	I11	n.c.
	X7	I13/I14	24 V <sub>ext out</sub>	I14	0 V <sub>ext out</sub>	I13	n.c.
	X8	I15/I16	24 V <sub>ext out</sub>	I16	0 V <sub>ext out</sub>	I15	n.c.
	ADDR (dummy plug)	connection for ASi addressing device					
BWU3163	X1	I1/I2	24 V <sub>out of ASi</sub>	I2	0 V <sub>out of ASi</sub>	I1	n.c.
	X2	I3/I4	24 V <sub>out of ASi</sub>	I4	0 V <sub>out of ASi</sub>	I3	n.c.
	X3	I5/I6	24 V <sub>out of ASi</sub>	I6	0 V <sub>out of ASi</sub>	I5	n.c.
	X4	I7/I8	24 V <sub>out of ASi</sub>	I8	0 V <sub>out of ASi</sub>	I7	n.c.
	X5	O1/O2	0 V <sub>ext out</sub>	O2	0 V <sub>ext out</sub>	O1	n.c.
	X6	O3/O4	0 V <sub>ext out</sub>	O4	0 V <sub>ext out</sub>	O3	n.c.
	X7	O5/O6	0 V <sub>ext out</sub>	O6	0 V <sub>ext out</sub>	O5	n.c.
	X8	O7/O8	0 V <sub>ext out</sub>	O8	0 V <sub>ext out</sub>	O7	n.c.
	ADDR (dummy plug)	connection for ASi addressing device					
BWU3802	X1	I1	24 V <sub>out of ASi</sub>	n.c.	0 V <sub>out of ASi</sub>	I1	n.c.
	X2	I2	24 V <sub>out of ASi</sub>	n.c.	0 V <sub>out of ASi</sub>	I2	n.c.
	X3	I3	24 V <sub>out of ASi</sub>	n.c.	0 V <sub>out of ASi</sub>	I3	n.c.
	X4	I4	24 V <sub>out of ASi</sub>	n.c.	0 V <sub>out of ASi</sub>	I4	n.c.
	X5	I5	24 V <sub>out of ASi</sub>	n.c.	0 V <sub>out of ASi</sub>	I5	n.c.
	X6	I6	24 V <sub>out of ASi</sub>	n.c.	0 V <sub>out of ASi</sub>	I6	n.c.
	X7	I7	24 V <sub>out of ASi</sub>	n.c.	0 V <sub>out of ASi</sub>	I7	n.c.
	X8	I8	24 V <sub>out of ASi</sub>	n.c.	0 V <sub>out of ASi</sub>	I8	n.c.
	ADDR (dummy plug)	connection for ASi addressing device					

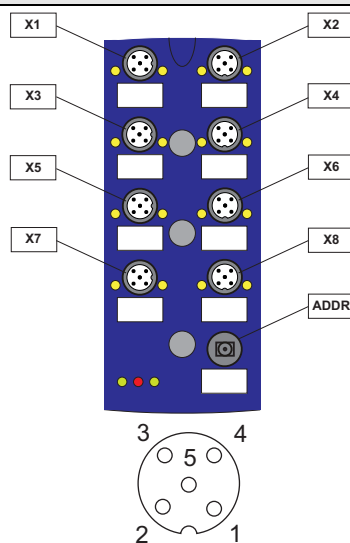

Connections							
Article no.	M12 connection	Marking	Pin1	Pin2	Pin3	Pin4	Pin5
BWU3893	X1	I1	24 V <sub>ext out</sub>	n.c.	0 V <sub>ext out</sub>	I1	n.c.
	X2	I2	24 V <sub>ext out</sub>	n.c.	0 V <sub>ext out</sub>	I2	n.c.
	X3	I3	24 V <sub>ext out</sub>	n.c.	0 V <sub>ext out</sub>	I3	n.c.
	X4	I4	24 V <sub>ext out</sub>	n.c.	0 V <sub>ext out</sub>	I4	n.c.
	X5	I5	24 V <sub>ext out</sub>	n.c.	0 V <sub>ext out</sub>	I5	n.c.
	X6	I6	24 V <sub>ext out</sub>	n.c.	0 V <sub>ext out</sub>	I6	n.c.
	X7	I7	24 V <sub>ext out</sub>	n.c.	0 V <sub>ext out</sub>	I7	n.c.
	X8	I8	24 V <sub>ext out</sub>	n.c.	0 V <sub>ext out</sub>	I8	n.c.
	ADDR (dummy plug)	connection for ASi addressing device					
BWU4207	X1	I1/I2	24 V <sub>ext out</sub>	I2	0 V <sub>ext out</sub>	I1	n.c.
	X2	I3/I4	24 V <sub>ext out</sub>	I4	0 V <sub>ext out</sub>	I3	n.c.
	X3	I5/I6	24 V <sub>ext out</sub>	I6	0 V <sub>ext out</sub>	I5	n.c.
	X4	I7/I8	24 V <sub>ext out</sub>	I8	0 V <sub>ext out</sub>	I7	n.c.
	X5	O1/O2	24 V <sub>ext out</sub>	O2	0 V <sub>ext out</sub>	O1	n.c.
	X6	O3/O4	24 V <sub>ext out</sub>	O4	0 V <sub>ext out</sub>	O3	n.c.
	X7	O5/O6	24 V <sub>ext out</sub>	O6	0 V <sub>ext out</sub>	O5	n.c.
	X8	O7/O8	24 V <sub>ext out</sub>	O8	0 V <sub>ext out</sub>	O7	n.c.
	ADDR (dummy plug)	connection for ASi addressing device					

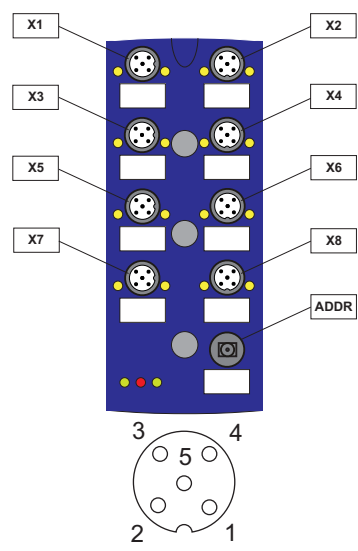

### Mounting according to cable direction

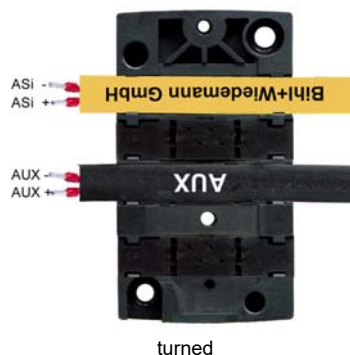
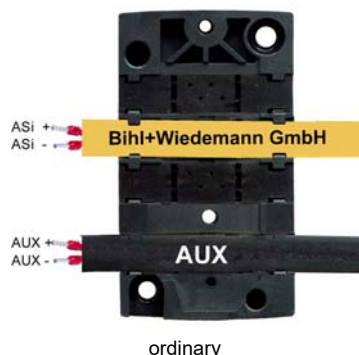

### Line termination with sealing profiles / as junction

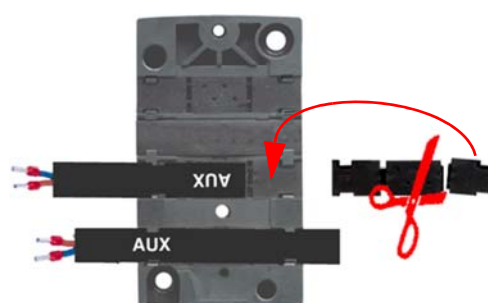
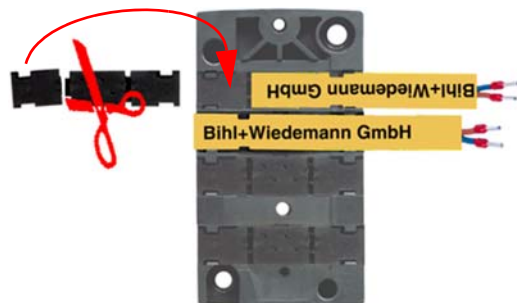
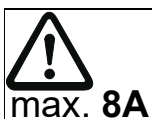

### Accessories:

- ASi substructure module (CNOMO) for 8 channel module in 60 mm housing, screw mounting (art. no. BW2351)
- ASi substructure module (CNOMO) for 8 channel module in 60 mm housing, DIN rail mounting (art. no. BW3516)
- Protection caps for unused M12 sockets (art. no. BW2368)
- Protection caps for ASi-5 addressing socket (art. no. BW4056)
- Sealing profile IP67 (IDC plug), 60 mm (art. no. BW3282)