

New standard ASi-5



(figure similar)



Figure	Type	Inputs digital	Outputs digital	M12 connection (1)	Input voltage (sensor supply) (2)	Output voltage (actuator supply) (3)	ASi connection (4)	ASi address (5)	Max. output current	Art. no.
	IP67, 8 x M12 ASi-5	8	–	single	out of ASi	–	ASi via M12	1 ASi-5 slave	–	BWU4195
	IP67, 8 x M12 ASi-5	8	8 x electronic	Y	out of ASi	out of AUX	ASi via M12	1 ASi-5 slave	1 A per output	BWU4193
	IP67, 8 x M12 ASi-5	16	–	Y	out of ASi	–	ASi via M12	1 ASi-5 slave	–	BWU4194
	IP67, 8 x M12 ASi-5	16	–	Y	out of AUX	–	ASi via M12	1 ASi-5 slave	–	BWU4196

(1) **M12 wiring:** either as a single-wiring, Y-wiring or mixed-wiring.

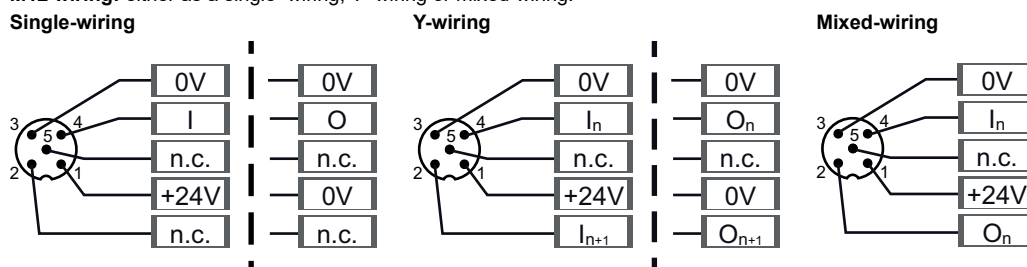

- (2) **Input voltage (sensor supply):** inputs are supplied by ASi or by AUX (auxiliary 24 V power). If supplied by ASi, inputs shall not be connected to earth or to external potential.
- (3) **Output voltage (actuator supply):** outputs are supplied by ASi or by AUX (auxiliary 24 V power). If supplied by ASi, outputs shall not be connected to earth or to external potential
- (4) **ASi connection:** the connection to ASi as well to AUX (auxiliary 24 V power) is made via yellow resp. black ASi profile cable with piercing technology or via M12 socket (in IP20 via clamps).
- (5) **ASi address:** AB slave (max. 62 AB slaves/ASi network), 2 AB slaves (max. 31 modules with 2 AB slaves), single slaves (max. 31 single slaves/ASi network) ASi-5 slave (max. 62 ASi-5 slaves/ASi network), mixed use allowed (upon request, slaves are available with specific ASi slave profiles).

Article No.	BWU4195	BWU4194	BWU4196	BWU4193
General data				
Device type	input			input / output
Connection				
ASi/AUX connection	M12 ⁽¹⁾			
Periphery connection	M12, single wiring	M12, Y wiring		
Length of connector cable	unlimited ⁽²⁾			
ASi				
Address	1 ASi-5 slave			
Required Master profile	M5			
As of ASi specification	5			
Operating voltage	30 V (18 ... 31.6 V)			
Max. current consumption	120+70 mA			
Max. current consumption without sensor/ actuator supply	70 mA			
AUX				
Operating voltage	–		24 V (18 ... 30 V)	
Max. current consumption	–		1 A	4 A
Input				
Number	8	16		8
Power supply	out of ASi		out of AUX	out of ASi
Sensor supply	short-circuit and overload protected according to EN 61131-2			
Power supply of attached sensors	up to +40 °C	120 mA ⁽³⁾	1 A ⁽⁷⁾	120 mA ⁽⁹⁾
	at +55 °C	80 mA ⁽³⁾	0,9 A ⁽⁶⁾	70 mA ⁽⁷⁾
	at +70 °C	50 mA ⁽³⁾	0,5 A ⁽⁶⁾	50 mA ⁽⁷⁾
Switching threshold	U<5 V (low) U>15 V (high)			
Output				
Number	–			8
Power supply	–			out of AUX
Output	–			short-circuit and overload protected according to EN 61131-2
Max. output current	up to +40 °C	–		1 A per output, $\Sigma(\text{Out})$ 4 A ⁽¹⁰⁾
	at +55 °C	–		1 A per output, $\Sigma(\text{Out})$ 2 A ⁽⁸⁾
	at +70 °C	–		
Display				
LED ASi (green)	on: ASi voltage on flashing: ASi voltage on, but peripheral fault ⁽⁴⁾ or address 0 off: no ASi voltage			
LED FLT/FAULT (red)	on: slave address 0 or slave offline flashing: peripheral fault ⁽⁴⁾ off: slave online			
LED AUX (green)	–		on: 24 V _{DC} AUX off: no 24 V _{DC} AUX	
LEDs I1 ... I _n (yellow)	state of inputs I1 ... I8	state of inputs I1 ... I16		state of inputs I1 ... I8
LEDs O1 ... O _n (yellow)	–			yellow: state of outputs O1 ... O8

Article No.	BWU4195	BWU4194	BWU4196	BWU4193
Environment				
Applied standards	EN 61000-6-2 EN 61000-6-3 EN 61131-2 EN 60529			
Passive safety (up to PLe/SIL 3)	yes ⁽⁵⁾		no ⁽⁸⁾	
Operating altitude	max. 2000 m			
Ambient temperature	-30 °C ... +55 °C (up to max. +70 °C) ⁽³⁾ ⁽⁶⁾ ⁽⁷⁾ ⁽⁸⁾			
Storage temperature	-25 °C ... +85 °C			
Housing	plastic, for screw mounting			
Pollution degree	2			
Protection category	IP67			
Tolerable loading referring to humidity	according to EN 61131-2			
Max. tolerable shock load	30g, 11 ms, acc. EN 61131-2			
Max. tolerable vibration stress	5 ... 8 Hz 50 mm _{pp} /8 ... 500 Hz 6g, acc. EN 61131-2			
Insulation voltage	≥ 500 V			
Weight	200 g			
Dimensions (W / H / D) in mm	60 / 151 / 31			

- (1) **Line protection:**
If the module is supplied via a M12 connection with A or B coding, it may only be used with a current load of max. 4 A per pin in acc. with IEC 61076-2-101 and IEC 61076-2-109. A fused tap is recommended. There is no such limitation for modules supplied via piercing contacts.

Connection to ASi and AUX via M12

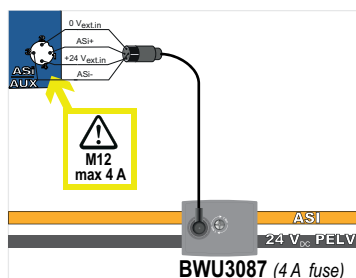

via piercing contacts

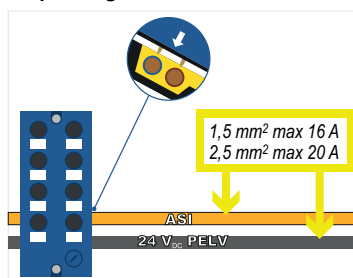

- (2) Loop resistance ≤ 150 Ω

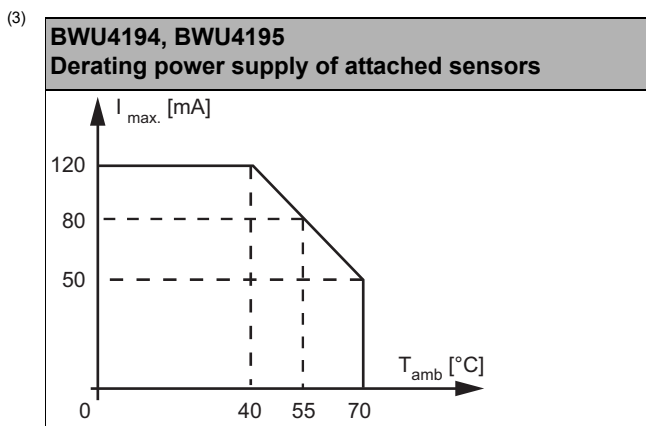

- (4) See table "Peripheral fault indication"
- (5) Exclusion of errors for the connection of the two ASi and AUX potentials can be assumed in the module. Passive safety for the application can only be achieved if this is ensured for all components used.
- (6) Maximum ambient operating temperature +55 °C according UL certificate for the use in the USA and Canada

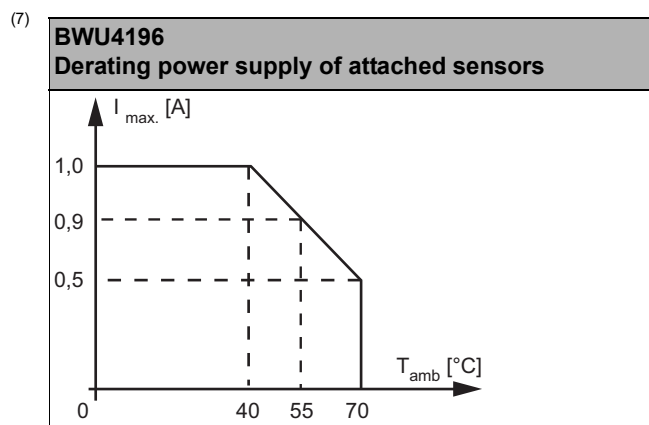

(8) Exclusion of errors for the connection of the two ASi and AUX potentials cannot be assumed in the module. It is not possible to achieve passive safety for the application with this module.

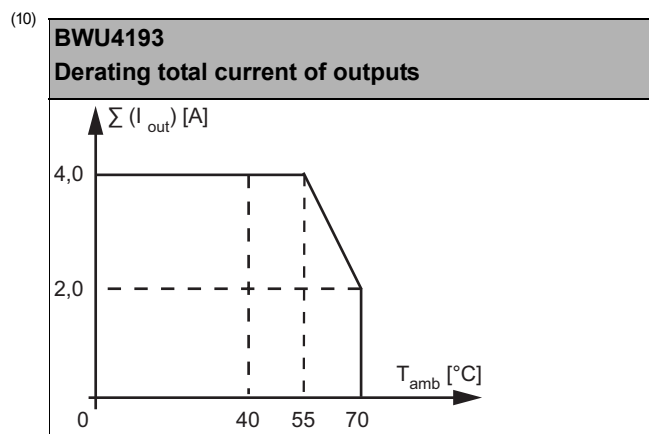
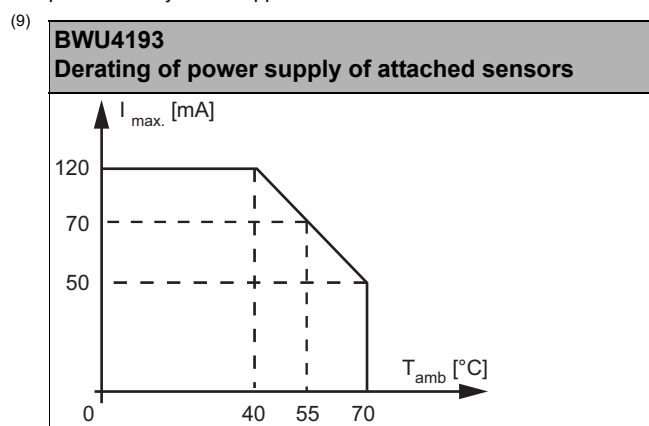

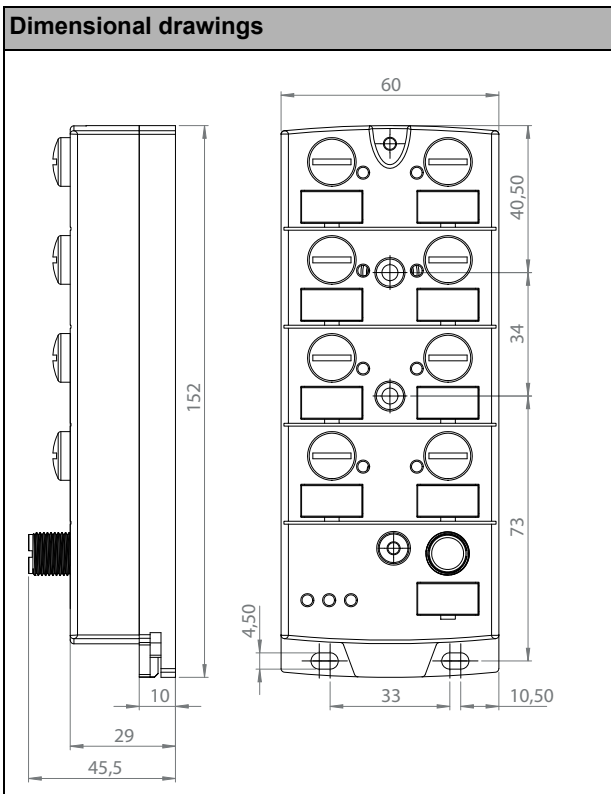

Article no.	Peripheral fault indication		
	Overload sensor supply	Output short circuited	AUX voltage missing
BWU4193	•	•	•
BWU4194	•	-	-
BWU4195	•	-	-
BWU4196	•	-	•

UL-specifications (UL508)	
BWU4193, BWU4194, BWU4195, BWU4196	
External protection	An isolated source with a secondary open circuit voltage of $\leq 30 V_{DC}$ with a 3 A maximum over current protection. Over current protection is not required when a Class 2 source is employed.
In general	UL mark does not provide UL certification for any functional safety rating or aspects of the above devices.

Programming: ASi bit assignment

Article no.	Byte	Bit							
		D7	D6	D5	D4	D3	D2	D1	D0
		input							
BWU4193, BWU4194, BWU4195, BWU4196	0	I8	I7	I6	I5	I4	I3	I2	I1
BWU4194, BWU4196	1	I16	I15	I14	I13	I12	I11	I10	I9

Article no.	Byte	Bit							
		D7	D6	D5	D4	D3	D2	D1	D0
		output							
BWU4193	0	O8	O7	O6	O5	O4	O3	O2	O1

Pin assignment

Signal name	Explanation
Ix	digital input x
Ox	digital output x
24V _{ext out}	power supply, out of external voltage, positive pole (AUX, actuator supply)
0V _{ext out}	power supply, out of external voltage, negative pole (AUX, actuator supply)
24V _{out of ASi}	power supply, out of ASi, positive pole (sensor supply)
0V _{out of ASi}	power supply, out of ASi, negative pole (sensor supply)
ASi +, ASi -	connection to ASi bus
n.c. (not connected)	not connected

Connections							
Article no.	M12 connection	Marking	Pin1	Pin2	Pin3	Pin4	Pin5
BWU4194	X1	I1/I2	24 V _{out of ASi}	I2	0 V _{out of ASi}	I1	n.c.
	X2	I3/I4	24 V _{out of ASi}	I4	0 V _{out of ASi}	I3	n.c.
	X3	I5/I6	24 V _{out of ASi}	I6	0 V _{out of ASi}	I5	n.c.
	X4	I7/I8	24 V _{out of ASi}	I8	0 V _{out of ASi}	I7	n.c.
	X5	I9/I10	24 V _{out of ASi}	I10	0 V _{out of ASi}	I9	n.c.
	X6	I11/I12	24 V _{out of ASi}	I12	0 V _{out of ASi}	I11	n.c.
	X7	I13/I14	24 V _{out of ASi}	I14	0 V _{out of ASi}	I13	n.c.
	X8	I15/I16	24 V _{out of ASi}	I16	0 V _{out of ASi}	I15	n.c.
	ASi	ASi	ASi+	n.c.	ASi-	n.c.	-
BWU4196	X1	I1/I2	24 V _{ext out}	I2	0 V _{ext out}	I1	n.c.
	X2	I3/I4	24 V _{ext out}	I4	0 V _{ext out}	I3	n.c.
	X3	I5/I6	24 V _{ext out}	I6	0 V _{ext out}	I5	n.c.
	X4	I7/I8	24 V _{ext out}	I8	0 V _{ext out}	I7	n.c.
	X5	I9/I10	24 V _{ext out}	I10	0 V _{ext out}	I9	n.c.
	X6	I11/I12	24 V _{ext out}	I12	0 V _{ext out}	I11	n.c.
	X7	I13/I14	24 V _{ext out}	I14	0 V _{ext out}	I13	n.c.
	X8	I15/I16	24 V _{ext out}	I16	0 V _{ext out}	I15	n.c.
	ASi/AUX	ASi/AUX	ASi+	0 V _{ext in}	ASi-	24 V _{ext in}	-
BWU4193	X1	I1/I2	24 V _{out of ASi}	I2	0 V _{out of ASi}	I1	n.c.
	X2	I3/I4	24 V _{out of ASi}	I4	0 V _{out of ASi}	I3	n.c.
	X3	I5/I6	24 V _{out of ASi}	I6	0 V _{out of ASi}	I5	n.c.
	X4	I7/I8	24 V _{out of ASi}	I8	0 V _{out of ASi}	I7	n.c.
	X5	O1/O2	0 V _{ext out}	O2	0 V _{ext out}	O1	n.c.
	X6	O3/O4	0 V _{ext out}	O4	0 V _{ext out}	O3	n.c.
	X7	O5/O6	0 V _{ext out}	O6	0 V _{ext out}	O5	n.c.
	X8	O7/O8	0 V _{ext out}	O8	0 V _{ext out}	O7	n.c.
	ASi/AUX	ASi/AUX	ASi+	0 V _{ext in}	ASi-	24 V _{ext in}	-
BWU4195	X1	I1	24 V _{out of ASi}	n.c.	0 V _{out of ASi}	I1	n.c.
	X2	I2	24 V _{out of ASi}	n.c.	0 V _{out of ASi}	I2	n.c.
	X3	I3	24 V _{out of ASi}	n.c.	0 V _{out of ASi}	I3	n.c.
	X4	I4	24 V _{out of ASi}	n.c.	0 V _{out of ASi}	I4	n.c.
	X5	I5	24 V _{out of ASi}	n.c.	0 V _{out of ASi}	I5	n.c.
	X6	I6	24 V _{out of ASi}	n.c.	0 V _{out of ASi}	I6	n.c.
	X7	I7	24 V _{out of ASi}	n.c.	0 V _{out of ASi}	I7	n.c.
	X8	I8	24 V _{out of ASi}	n.c.	0 V _{out of ASi}	I8	n.c.
	ASi	ASi	ASi+	n.c.	ASi-	n.c.	-

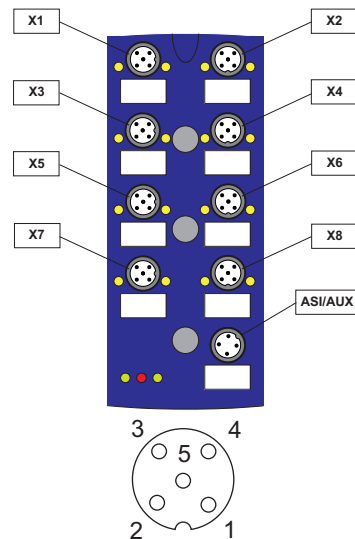

Mounting according to cable direction

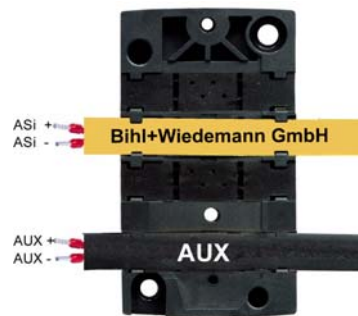

ordinary

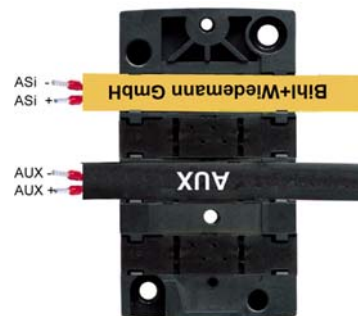

turned

Line termination with sealing profiles / as junction

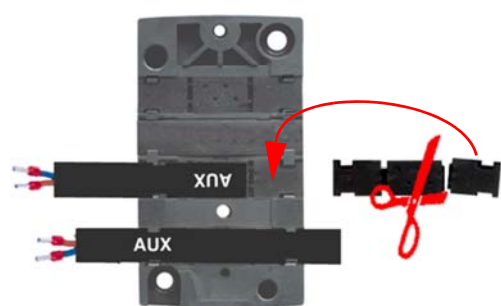
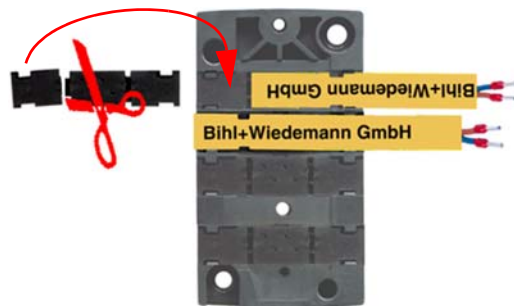

Accessories:

- Protection caps for unused M12 sockets (art. no. BW2368)
- Passive Distributor ASI/AUX to 2 x M12 socket, internal protection via changeable 4 A slow-blow fuses (art. no. BWU3087)
- It is recommended to use pre-assembled cables to connect the power source with the module.